









ASSEMBLY INSTRUCTIONS FOR JEWELRY ARMOIRE

ITEM: #GH13023

NO.	Description	Q'ty	Sketch	NO.	Description	Q'ty	Sketch
A	Right Front Leg	2pcs		E	Machine Screw	4pcs	
	Left Back Leg						
B	Left Front Leg	2pcs		F	Washer	4pcs	
	Right Back Leg						
C	Armoire	1pc		G	Screwdriver	1pcs	
				H	Small Wood Screw	5pcs	
D	Top	1pc		I	Wood Dowel	8pcs	

1. Lie the Armoire (C) on a towel. Attach the 1 Right Front Leg and 1 Left Back Leg (A), and 1 Left Front Leg and 1 Right Back Leg (B) to the bottom of the Armoire (C) with 8 Machine Screws (E), 8 Washers (F) and 8 Wood Dowel by using Screwdriver (G).

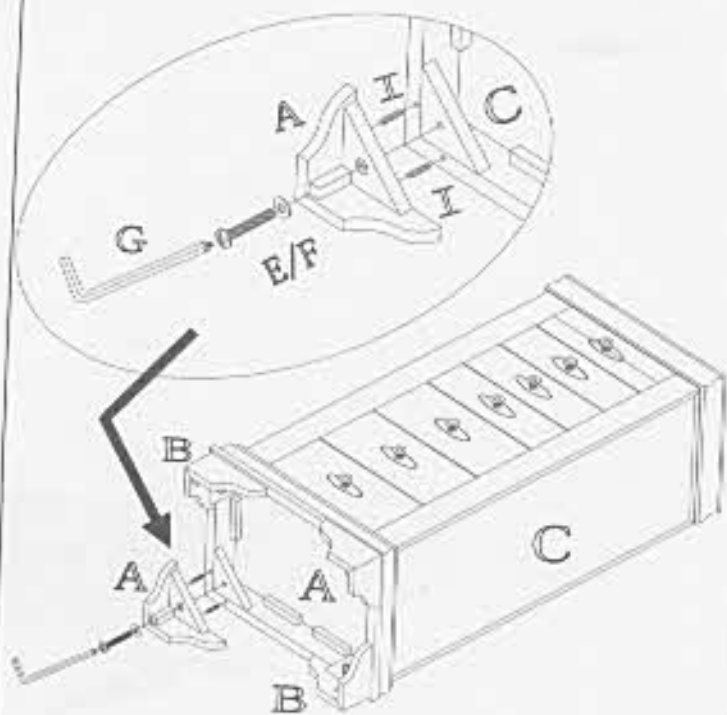

2. Carefully stand armoire upright on Legs, attached Top (D) to hinge at rear of the Armoire (C) with 5 Small Wood Screws (H) by using Screwdriver (G).

